

IB957

Intel® Arrandale™ /PCH
5.25" Motherboard

USER'S MANUAL

Version 1.0

Acknowledgments

AMI is a registered trademark of American Megatrends Inc.

PS/2 is a trademark of International Business Machines Corporation.

Intel and Intel® Arrandale DC Mobile Processor are registered trademarks of Intel Corporation.

Microsoft Windows is a registered trademark of Microsoft Corporation.

Fintek is a registered trademark of Fintek Electronics Corporation.

All other product names or trademarks are properties of their respective owners.

Table of Contents

Introduction	1
Product Description.....	1
Checklist.....	2
IB957 Specifications	3
Board Dimensions	4
Installations	6
Installing the Memory	7
Setting the Jumpers	8
Connectors on IB957.....	12
BIOS Setup.....	23
Drivers Installation	51
Intel Chipset Software Installation Utility.....	52
VGA Drivers Installation	54
Realtek HD Audio Driver Installation.....	56
LAN Drivers Installation.....	57
Intel® Management Engine Interface	60
Appendix	63
A. I/O Port Address Map.....	63
B. Interrupt Request Lines (IRQ)	64
C. Watchdog Timer Configuration.....	65

IMPORTANT NOTE: *When the system boots without the CRT being connected, there will be no image on screen when you insert the CRT/VGA cable. To show the image on screen, the hotkey must be pressed (CTRL-ALT-F1).*

Introduction

Product Description

The IB957 5.25" Disk-Size SBC is a high performance Intel® Core™ i7-610E (2.53GHz/4MB) Processor-based IB957 5.25" Disk-Size SBC with the mobile Intel® QM57 Express Chipset. It is designed for a range of automation, industrial, and medical applications. The Intel® Core™ i7 Mobile processor has an optimized integrated graphics solution.

IB957 features a low-power design that is validated with Intel® Core™ i7/i3 Mobile processors on 32nm process. With two dual-channel DDR3 800/1066MHz DIMM sockets that support ECC memory, the SBC can be populated with up to 8GB of system memory. Connectivity includes a Gigabit Ethernet port, up to 12 USB 2.0 ports, four SATA ports, a HDMI, LVDS, DisplayPort, DVI-D and VGA display connector. A Mini PCI-E (Mini Card) slot is available for expansion. Dimensions are 203mm x 146mm.

IB957 FEATURES:

- Supports Intel® i7-610E (2.53GHz/4MB cache) or i3-330E (2.13GHz/3MB cache)
- Two DDR3 w/ ECC DIMM, Max. 8GB memory
- Onboard Gigabit Ethernet
- Integrated Graphics VGA for CRT/DVI/ HDMI/LVDS/DisplayPort
- 4x SATA, 12x USB 2.0, 4x COM, Watchdog timer
- Digital I/O, Mini PCI-E socket (Mini Card)

Checklist

Your IB957 package should include the items listed below.

- The IB957 SBC
- This User's Manual
- 1 CD containing chipset drivers and flash memory utility
- Serial port cable (Part # PK1HK, 30cm)
- SATA cable (Part # SATA-7F, 46cm)

IB957 Specifications

CPU Supported	Intel® Arrandale+ECC processor - i7-610E (2.53GHz/4M Cache/ 2 cores/4 Threads/35W) - i3-330E (2.13GHz/3M Cache/ 2 cores/4 Threads/35W)
CPU Voltage	0.700V ~ 1.5V (IMVP-6.5)
System Speed	Up to 3.0GHz or above
CPU FSB	1066MHz FSB
Cache	Up to 4MB shared L3 Cache
Green /APM	APM1.2
CPU Tpye	FcBGA1288
Chipset	Intel Ibx Peak-M (PCH) Chipset PCH: 25mm x 27mm, 1071-pin FCBGA
BIOS	AMI BIOS, supports ACPI function
Memory	DDR3-800/1066 DIMM x2 (w/ECC function), Max. 8GB
VGA	Arrandale DC mobile processor integrated graphics Supports CRT, DVI Supports HDMI, DP(DisplayPort)
LVDS LCD Panel	Arrandale DC mobile processor built-in, supports 24-bit, single or dual channel LVDS
LAN	PCH 10/100/gigabit MAC + PHY <ul style="list-style-type: none"> Intel 82577LM 10/100/1000
USB	PCH built-in USB 2.0 host controller, support 12 ports
Serial ATA Ports	PCH built-in SATA controller, supports 4 ports
IAMT6.0	PCH built-in Intel Active Management Technology VER 6.0 with HW KVM(MI957-i7-610E only)
Audio	PCH built-in High Definition audio controller: ALC888 w/ 5.1 channels
LPC I/O	F81865F: COM1, COM2 (RS232/RS422/RS485), COM3 and COM4 Hardware monitor (3 thermal, 4 voltage monitor inputs, 2 fan headers)
Digital IO	4 in & 4 out
Keyboard/Mouse	Supports PS/2 keyboard/mouse connector
Expansion Slots	Mini PCIE socket x1
Edge Connector	PS/2 connector x1 for keyboard/mouse and dual USB stack connector Gigabit LAN RJ-45 + dual USB stack connector x1 DP Connector x1 + dual USB stack connector x1 HDMI connector x1 DVI-D and DB15 (VGA) stack connector x1 Quad USB stack connector x1 RCA Jack 3x1 for Audio (Front-Out, Line-In, Mic)
Onboard Header/ Connector	10-pin headerx1 for Digital I/O; 10-pin header x2 for COM1,COM2 20-pin header x1 for COM3, COM4 26-pin header x1 for Printer 10-pin header x 2 for USB 9,10,11,12 DF13 connector x2 for LVDS; 10-pin header x1 for audio Line-Out & Mic 4-pin header x1 for CD in, SPDIF-out connector x1 SATA connector x4 for SATA ports
Watchdog Timer	Yes (256 segments, 0, 1, 2,...255 sec/min)
System Voltage	+5V, +3.3V, +12V, -12V, 5VSB
Others	Modem Wakeup, LAN Wakeup
Board Size	203mm x 146mm (5.25")

Board Dimensions

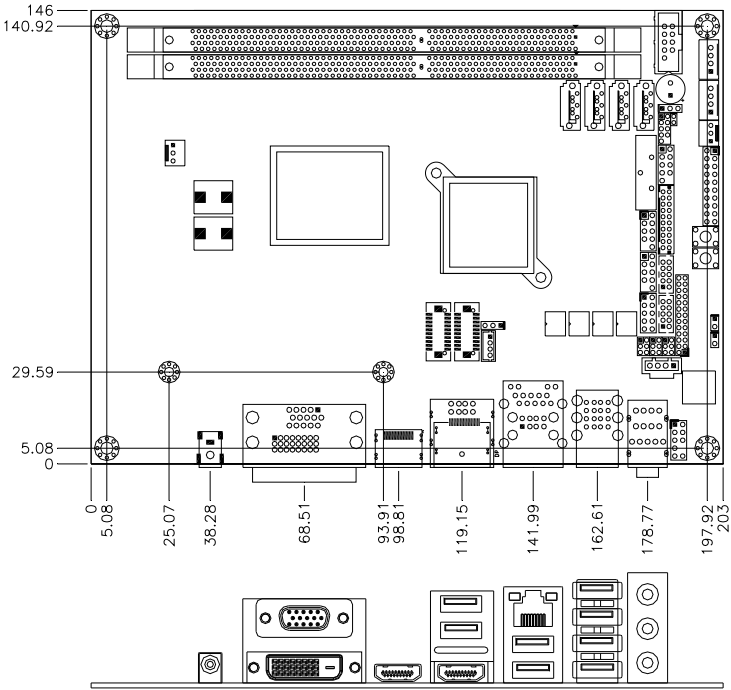

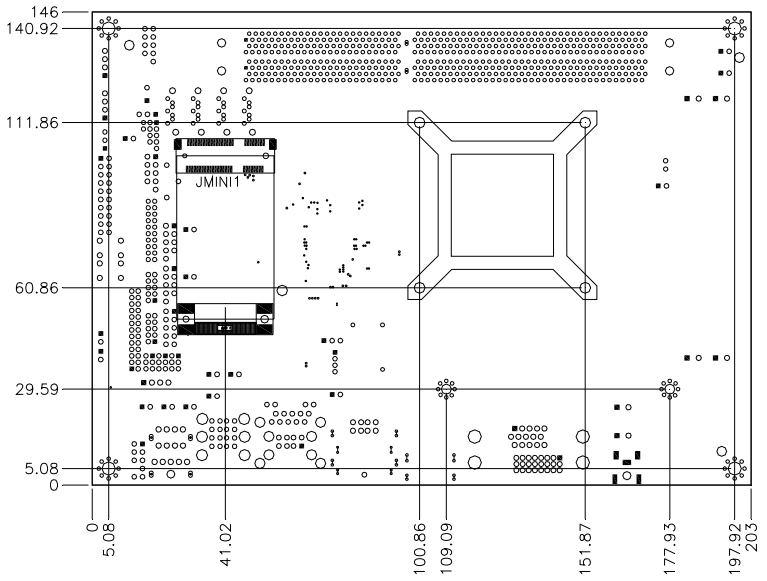

Installations

This section provides information on how to use the jumpers and connectors on the IB957 in order to set up a workable system. The topics covered are:

Installing the Memory	7
Setting the Jumpers	8
Connectors on IB957	12

Installing the Memory

The IB957 board supports two DDR3 memory socket for a maximum total memory of 8GB in DDR3 w/ECC DIMM memory type.

Installing and Removing Memory Modules

To install the DDR3 modules, locate the memory slot on the board and perform the following steps:

1. Hold the DDR3 module so that the key of the DDR3 module aligned with that on the memory slot.
2. Gently push the DDR3 module in an upright position until the clips of the slot close to hold the DDR3 module in place when the DDR3 module touches the bottom of the slot.
3. To remove the DDR3 module, press the clips with both hands.

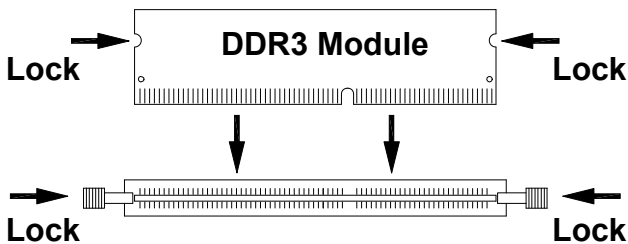

Setting the Jumpers

Jumpers are used on IB957 to select various settings and features according to your needs and applications. Contact your supplier if you have doubts about the best configuration for your needs. The following lists the connectors on IB957 and their respective functions.

Jumper Locations on IB957	9
JP2: LCD Panel Power Selection.....	10
JP3, JP4, JP5: RS232/422/485 (COM2) Selection	10
JBAT1: Clear CMOS Setting.....	11

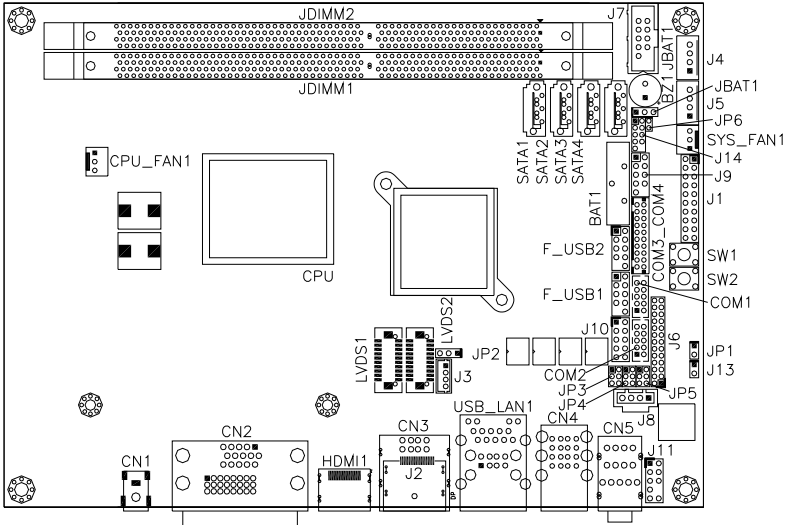

IMPORTANT NOTE: When the system boots without the CRT being connected, there will be no image on screen when you insert the CRT/VGA cable. To show the image on screen, the hotkey must be pressed.

Jumper Locations on IB957



Jumpers on IB957	Page
JP2: LCD Panel Power Selection	10
JP3, JP4, JP5: RS232/422/485 (COM2) Selection	10
JBAT1: Clear CMOS Setting	11

JP2: LCD Panel Power Selection

JP2	LCD Panel Power
	3.3V
	5V

JP3, JP4, JP5: RS232/422/485 (COM2) Selection

COM1 is fixed for RS-232 use only.

COM2 is selectable for RS232, RS-422 and RS-485.

The following table describes the jumper settings for COM2 selection.

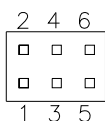



COM2 Function	RS-232	RS-422	RS-485
Jumper Setting (pin closed)	JP3: 1-2	JP3: 3-4	JP3: 5-6
	JP4: 3-5 & 4-6	JP4: 1-3 & 2-4	JP4: 1-3 & 2-4
	JP5: 3-5 & 4-6	JP5: 1-3 & 2-4	JP5: 1-3 & 2-4

COM2 is jumper selectable for RS-232, RS-422 and RS-485.

Pin #	Signal Name		
	RS-232	R2-422	RS-485
1	DCD	TX-	DATA-
2	RX	TX+	DATA+
3	TX	RX+	NC
4	DTR	RX-	NC
5	Ground	Ground	Ground
6	DSR	RTS-	NC
7	RTS	RTS+	NC
8	CTS	CTS+	NC
9	RI	CTS-	NC
10	NC	NC	NC

JBAT1: Clear CMOS Setting

JBAT1	Setting
 1 2 3	Normal
 1 2 3	Clear CMOS

Connectors on IB957

Connector Locations on IB957	13
CN1: DC Adapter Connector.....	14
CN2: DVI-D and VGA Connector	14
HDMI1: HDMI Connector	15
CN3: USB11/12 Ports.....	15
J2: DisplayPort Connector	15
CN4: USB6/7/8/10 Ports	15
USB_LAN1: 10/100/1000 RJ-45 and USB9/13 Ports.....	15
CN5: Audio Connector	15
COM3_COM4: COM3, COM4 Serial Port	16
SYS_FAN1: System Fan Power Connector	16
CPU_FAN1: CPU Fan Power Connector.....	16
J1 (F_PANEL): System Function Connector	17
J3: LCD Backlight Connector.....	19
J4, J5: +12V and +5V Output Power Connectors.....	19
J6: Printer Port Connectors	19
J7: SPI Flash Connector (factory use only)	19
J8: CD-In Pin Header.....	19
J9: PS/2 Keyboard/Mouse Connector.....	19
J10: Digital I/O	20
J11: Front Audio Connector	20
J12: PCI-E(x1) Slot.....	20
J13: SPDIF Out Connector	20
JMINI: Mini PCIE Connector.....	20
SATA1, SATA2, SATA3, SATA4: SATA Connectors	20
F_USB1: USB1/USB5 Connector	21
F_USB2: USB0/USB3 Connector	21
COM1,COM2: COM1,COM2 Serial Port.....	21
LVDS1, LVDS2: LVDS Connectors (1st channel, 2nd channel).....	22

Connector Locations on IB957

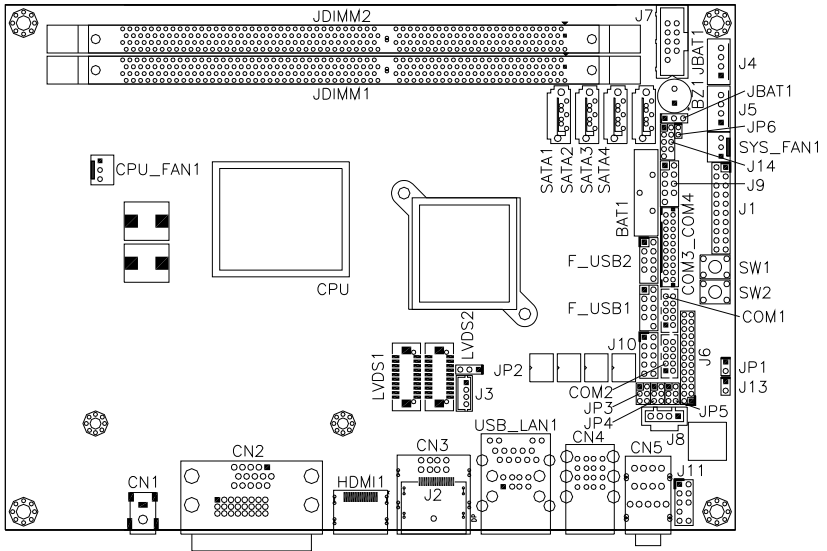

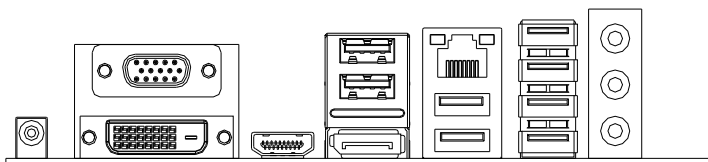

CN1: DC Adapter Connector

CN1 provides DC12V that provide system power +5,+3.3,+12V,5VSB

CN2: DVI-D and VGA Connector

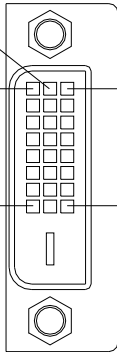

Signal Name	Pin #	Pin #	Signal Name
DATA 2-	1	16	HOT PLUG
DATA 2+	2	17	DATA 0-
Shield 2/4	3	18	DATA 0+
DATA 4-	4	19	SHIELD 0/5
DATA 4+	5	20	DATA 5-
DDC CLOCK	6	21	DATA 5+
DDC DATA	7	22	SHIELD CLK
N.C	8	23	CLOCK -
DATA 1-	9	24	CLOCK +
DATA 1+	10	C1	N.C.
SHIELD 1/3	11	C2	N.C.
DATA 3-	12	C3	N.C.
DATA 3+	13	C4	N.C.
DDC POWER	14	C5	N.C.
A GROUND 1	15	C6	N.C.

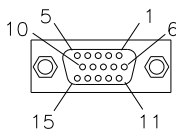

Signal Name	Pin #	Pin #	Signal Name
Red	1	2	Green
Blue	3	4	N.C.
GND	5	6	GND
GND	7	8	GND
N.C.	9	10	GND
N.C.	11	12	DDC_DATA
HSYNC	13	14	VSYNC
DDC_CLK	15		

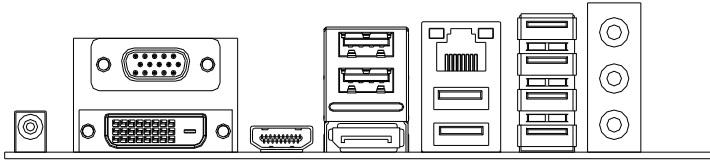

HDMI1: HDMI Connector

Signal Name	Pin #	Pin #	Signal Name
DATA 2-	1	13	DATA 3+
DATA 2+	2	14	+5V Power
Shield 2/4	3	15	GROUND
DATA 4-	4	16	HOT PLUG
DATA 4+	5	17	DATA 0-
DDC CLOCK	6	18	DATA 0+
DDC DATA	7	19	SHIELD 0/5
N.C	8	20	DATA 5-
DATA 1-	9	21	DATA 5+
DATA 1+	10	22	SHIELD CLK
SHIELD 1/3	11	23	CLOCK +
DATA 3-	12	24	CLOCK -

CN3: USB11/12 Ports

J2: DisplayPort Connector

CN4: USB6/7/8/10 Ports

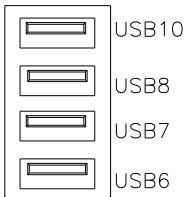

USB_LAN1: 10/100/1000 RJ-45 and USB9/13 Ports

CN5: Audio Connector

The audio connector, from top to bottom, is composed of Line in, Line out and Microphone jacks.

COM3_COM4: COM3, COM4 Serial Port

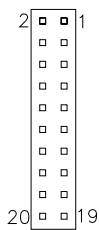

Signal Name	Pin #	Pin #	Signal Name
DSR	2	1	DCD
RTS	4	3	RXD
CTS	6	5	TXD
RI	8	7	DTR
NA	10	9	Ground
DSR	12	11	DCD
RTS	14	13	RXD
CTS	16	15	TXD
RI	18	17	DTR
NA	20	19	Ground

SYS_FAN1: System Fan Power Connector

This is a 3-pin header for system fans. The fan must be a 12V (500mA).



Pin #	Signal Name
1	Ground
2	+12V
3	Rotation detection

CPU_FAN1: CPU Fan Power Connector

This is a 3-pin header for the CPU fan. The fan must be a 12V fan.



Pin #	Signal Name
1	Ground
2	+12V
3	Rotation detection

J1 (F_PANEL): System Function Connector

J1 provides connectors for system indicators that provide light indication of the computer activities and switches to change the computer status. J2 is a 20-pin header that provides interfaces for the following functions.

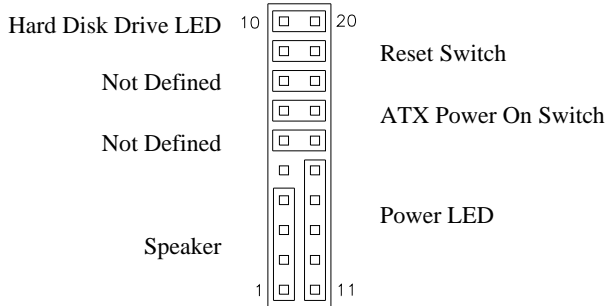

Speaker: Pins 1 - 4

This connector provides an interface to a speaker for audio tone generation. An 8-ohm speaker is recommended.

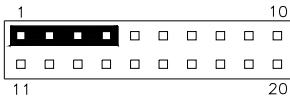

Pin #	Signal Name
1	Speaker out
2	No connect
3	Ground
4	+5V

Power LED: Pins 11 - 15

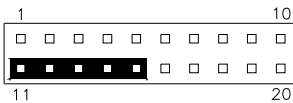

Pin #	Signal Name
11	Power LED
12	No connect
13	Ground
14	No connect
15	Ground

ATX Power ON Switch: Pins 7 and 17

This 2-pin connector is an “ATX Power Supply On/Off Switch” on the system that connects to the power switch on the case. When pressed, the power switch will force the system to power on. When pressed again, it will force the system to power off.

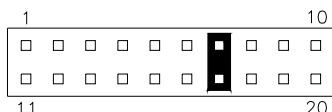

Reset Switch: Pins 9 and 19

The reset switch allows the user to reset the system without turning the main power switch off and then on again. Orientation is not required when making a connection to this header.

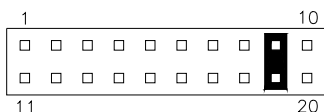

Hard Disk Drive LED Connector: Pins 10 and 20

This connector connects to the hard drive activity LED on control panel. This LED will flash when the HDD is being accessed.

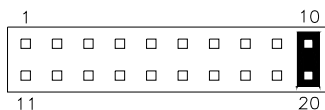

Pin #	Signal Name
10	HDD Active
20	5V

J3: LCD Backlight Connector



Pin #	Signal Name
1	+12V
2	Backlight Enable
3	Brightness Control
4	Ground

J4, J5: +12V and +5V Output Power Connectors

J6: Printer Port Connectors

J7: SPI Flash Connector (factory use only)

J8: CD-In Pin Header

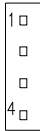

Pin #	Signal Name
1	CD Audio R
2	Ground
3	Ground
4	CD Audio L

J9: PS/2 Keyboard/Mouse Connector



Signal Name	Pin	Pin	Signal Name
Ground	1	2	Ground
Vcc	3	4	Vcc
MSDATA	5	6	KBDATA
MSCLK	7	8	KBCLK
NC	9	10	NC

J10: Digital I/O



Signal Name	Pin	Pin	Signal Name
GND	1	2	VCC
OUT3	3	4	OUT1
OUT2	5	6	OUT0
IN3	7	8	IN1
IN2	9	10	IN0

J11: Front Audio Connector

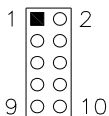

Signal Name	Pin #	Pin #	Signal Name
MIC2_L	1	2	Ground
MIC2_R	3	4	Presence#
Line2_L	5	6	MIC2_ID
Sense	7	8	NC
Line2_R	9	10	Line2_ID

J12: PCI-E(x1) Slot

J13: SPDIF Out Connector

JMINI: Mini PCIE Connector

SATA1, SATA2, SATA3, SATA4: SATA Connectors

F_USB1: USB1/USB5 Connector



Signal Name	Pin	Pin	Signal Name
Vcc	1	2	Vcc
D0-	3	4	D1-
D0+	5	6	D1+
Ground	7	8	Ground
NC	9	10	Ground

F_USB2: USB0/USB3 Connector

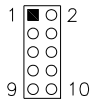

Signal Name	Pin	Pin	Signal Name
Vcc	1	2	Vcc
D0-	3	4	D1-
D0+	5	6	D1+
Ground	7	8	Ground
NC	9	10	Ground

COM1,COM2: COM1,COM2 Serial Port

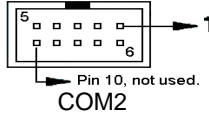

Signal Name	Pin #	Pin #	Signal Name
DCD, Data carrier detect	1	6	DSR, Data set ready
RXD, Receive data	2	7	RTS, Request to send
TXD, Transmit data	3	8	CTS, Clear to send
DTR, Data terminal ready	4	9	RI, Ring indicator
GND, ground	5	10	Not Used

LVDS1, LVDS2: LVDS Connectors (1st channel, 2nd channel)

The LVDS connectors on board consist of the first channel (LVDS1) and second channel (LVDS2).

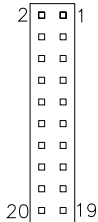

Signal Name	Pin #	Pin #	Signal Name
TX0-	2	1	TX0+
Ground	4	3	Ground
TX1-	6	5	TX1+
5V/3.3V	8	7	Ground
TX3-	10	9	TX3+
TX2-	12	11	TX2+
Ground	14	13	Ground
TXC-	16	15	TXC+
5V/3.3V	18	17	ENABKL
+12V	20	19	+12V

BIOS Setup

This chapter describes the different settings available in the AMI BIOS that comes with the board. The topics covered in this chapter are as follows:

BIOS Introduction	24
BIOS Setup	24
Main BIOS Setup	25
Advanced Settings	26
Chipset Settings	40
Boot Settings	46
Security Settings	47
Save & Exit Settings	48
Event Logs	50

BIOS Introduction

The BIOS (Basic Input/Output System) installed in your computer system's ROM supports Intel processors. The BIOS provides critical low-level support for a standard device such as disk drives, serial ports and parallel ports. It also provides password protection as well as special support for detailed fine-tuning of the chipset controlling the entire system.

BIOS Setup

The BIOS provides a Setup utility program for specifying the system configurations and settings. The BIOS ROM of the system stores the Setup utility. When you turn on the computer, the BIOS is immediately activated. Pressing the key immediately allows you to enter the Setup utility. If you are a little bit late pressing the key, POST (Power On Self Test) will continue with its test routines, thus preventing you from invoking the Setup. If you still wish to enter Setup, restart the system by pressing the "Reset" button or simultaneously pressing the <Ctrl>, <Alt> and <Delete> keys. You can also restart by turning the system Off and back On again. The following message will appear on the screen:

```
Press <DEL> to Enter Setup
```

In general, you press the arrow keys to highlight items, <Enter> to select, the <PgUp> and <PgDn> keys to change entries, <F1> for help and <Esc> to quit.

When you enter the Setup utility, the Main Menu screen will appear on the screen. The Main Menu allows you to select from various setup functions and exit choices.

Main BIOS Setup

This setup allows you to record some basic hardware configurations in your computer system and set the system clock.

Aptio Setup Utility						
Main	Advanced	Chipset	Boot	Security	Save & Exit	Event Logs
BIOS INFORMATION						
BIOS Vendor		American Megatrends				
Memory Information						
Total Memory		4096 MB (DDR3 1066)				
System Date		[Tue 01/06/2009]				
System Time		[00:08:21]				
Access Level		Administrator				
						→ ← Select Screen ↑ ↓ Select Item Enter: Select +- Change Field F1: General Help F2: Previous Values F3: Optimized Default F4: Save ESC: Exit

Note: If the system cannot boot after making and saving system changes with Setup, the AMI BIOS supports an override to the CMOS settings that resets your system to its default.

Warning: It is strongly recommended that you avoid making any changes to the chipset defaults. These defaults have been carefully chosen by both AMI and your system manufacturer to provide the absolute maximum performance and reliability. Changing the defaults could cause the system to become unstable and crash in some cases.

System Language

Choose the system default language.

System Date

Set the Date. Use Tab to switch between Data elements.

System Time

Set the Time. Use Tab to switch between Data elements.

Advanced Settings

This section allows you to configure and improve your system and allows you to set up some system features according to your preference.

Aptio Setup Utility	
Main	Advanced
Legacy OpROM Support	
Launch PXE OpROM	
Launch Storage OpROM	
▶ PCI Subsystem Settings	
▶ ACPI Settings	
▶ Wake up event setting	
▶ CPU Configuration	
▶ SATA Configuration	
▶ Thermal Configuration	
▶ Intel IGD SWSCI OpRegion	
▶ Intel TDT(AT-p) Configurations	
▶ USB Configuration	
▶ Super IO Configuration	
▶ H/W Monitor	
▶ Intelligent Power Sharing	
▶ AMT Configuration	
▶ Serial Port Console Redirection	
	→ ← Select Screen ↑ ↓ Select Item Enter: Select +- Change Field F1: General Help F2: Previous Values F3: Optimized Default F4: Save ESC: Exit

Launch PXE OpROM

Enable or Disable Boot Option for Legacy Network Devices.

Launch Storage OpROM

Enable or Disable Boot Option for Legacy Mass Storage Devices with Option ROM.

▶ Wake up event setting

Enable/Disable Wake up event.

▶ Intel TDT(AT-p) Configurations

Disabling TDT Allow user to login to platform. This is strictly for testing only. This does not disable TDT Services in ME.

PCI Subsystem Settings

This section allows you to configure the PCI, PCI-X and PCI Express settings.

Aptio Setup Utility						
Main	Advanced	Chipset	Boot	Security	Save & Exit	Event Logs
	PCI Bus Driver Version		V 2.02.01			
	PCI ROM Priority		EFI Compatible ROM			
	PCI Common Settings					
	PCI Latency Timer		32 PCI Bus Clocks			
	PCI Express Device Settings					
	Extended Tag		Disabled			
	No Snoop		Enabled			
	Maximum Payload		Auto			
	Maximum Read Request		Auto			
	PCI Express Link Settings					
	ASPM Support		Disabled			
	WARNING: Enabling ASPM may cause					
	Some PCI-E devices to fail					
						→ ← Select Screen ↑ ↓ Select Item Enter: Select +- Change Field F1: General Help F2: Previous Values F3: Optimized Default F4: Save ESC: Exit

PCI ROM Priority

In case of multiple Option ROMs (Legacy and EFI Compatible), specifies what PCI Option ROM to launch.

PCI Latency Timer

Value to be programmed into PCI Latency Timer Register.

Extended Tag

If ENABLED allows Device to use 8-bit Tag field as a requester.

No Snoop

Enables or Disables PCI Express Device No Snoop option.

Maximum Payload

Set Maximum Payload of PCI Express Device or allow System BIOS to select the value.

Maximum Read Request

Launches (Enabled/Disabled) the boot option for legacy network devices.

PCI Express Link Settings

Set Maximum Read Request Size of PCI Express Device or allow System BIOS to select the value.

ASPM Support

Set the ASPM Level:

Force L0 – Force all links to L0 State

AUTO – BIOS auto configure

DISABLE – Disables ASPM

ACPI Settings

Aptio Setup Utility

Main	Advanced	Chipset	Boot	Security	Save & Exit	Event Logs
	Enable ACPI Auto Configuration		Disabled			
	ACPI Sleep State		S3 (Suspend to R...)			
						→ ← Select Screen ↑ ↓ Select Item Enter: Select +- Change Field F1: General Help F2: Previous Values F3: Optimized Default F4: Save ESC: Exit

Enabled ACPI Auto Configuration

Enables or Disables BIOS ACPI Auto Configuration.

ACPI Sleep State

Select the highest ACPI sleep state the system will enter, when the SUSPEND button is pressed.

Wake up event settings

Aptio Setup Utility

Main	Advanced	Chipset	Boot	Security	Save & Exit	Event Logs
	Wake system with Fixed Time		Disabled			
	Wake up hour		0		→ ← Select Screen	
	Wake up minute		0		↑ ↓ Select Item	
	Wake up second		0		Enter: Select	
	Wake on Ring		Disabled		+ - Change Field	
	Wake on PCI PME		Disabled		F1: General Help	
	Wake on PCIE Wake Event		Disabled		F2: Previous Values	
					F3: Optimized Default	
					F4: Save ESC: Exit	

Wake system with Fixed Time

Enables or Disables System wake on alarm event. When enabled, System will wake on the hr::min:: sec specified.

Wake on Ring

The options are Disabled and Enabled.

Wake on PCI PME

The options are Disabled and Enabled.

CPU Configuration

This section shows the CPU configuration parameters.

Aptio Setup Utility						
Main	Advanced	Chipset	Boot	Security	Save & Exit	Event Logs
CPU Configuration						
Processor Type			Intel(R) Core(TM) i5 CPU			
EMT64			Supported			
Processor Speed			2394 MHz			
Processor Stepping			20652			
Microcode Revision			9			
Processor Cores			2			
Intel HT Technology			Supported			
Hyper-threading			Enabled			
Active Processor Cores			All			
Limit CPUID Maximum			Disabled			
Execute Disable Bit			Enabled			
Hardware Prefetcher			Enabled			
Adjacent Cache Line Prefetch			Enabled			
Intel Virtualization Technology			Disabled			
						→ ← Select Screen ↑ ↓ Select Item Enter: Select +- Change Field F1: General Help F2: Previous Values F3: Optimized Default F4: Save ESC: Exit

Hyper-threading

Enabled for Windows XP and Linux (OS optimized for Hyper-Threading Technology) and Disabled for other OS (OS not optimized for Hyper-Threading Technology). When Disabled, only one thread per enabled core is enabled.

Active Processor Cores

Number of cores to enable in each processor package.

Limit CPUID Maximum

Disabled for Windows XP.

Execute Disable Bit

XD can prevent certain classes of malicious buffer overflow attacks when combined with a supporting OS (Windows Server 2003 SP1, Windows XP SP2, SuSE Linux 9.2, Red Hat Enterprise 3 Update 3.)

Hardware Prefetcher

To turn on/off the MLC streamer prefetcher.

Adjacent Cache Line Prefetch

To turn on/off prefetching of adjacent cache lines.

Intel Virtualization Technology

When enabled, a VMM can utilize the additional hardware capabilities provided by Vanderpool Technology.

Power Technology

Enable the power management features.

SATA Configuration

SATA Devices Configuration.

Aptio Setup Utility

Main	Advanced	Chipset	Boot	Security	Save & Exit	Event Logs
SATA Configuration					→ ← Select Screen	
SATA Port0		Hitachi HDS721 (160.0GB)			↑ ↓ Select Item	
SATA Port1		Not Present			Enter: Select	
SATA Port2		Not Present			+- Change Field	
SATA Port3		Not Present			F1: General Help	
SATA Port4		Not Present			F2: Previous Values	
SATA Port5		ATAPI iHDS11 ATAPI			F3: Optimized Default	
SATA Mode		IDE Mode			F4: Save ESC: Exit	
Serial-ATA Controller 0		Compatible				
Serial-ATA Controller 1		Enhanced				

SATA Mode

Options are:

- (1) IDE Mode
- (2) AHCI Mode
- (3) RAID Mode

Serial-ATA Controller

Options are:

Disable

- (1) Enhanced
- (2) Compatible

Intel IGD SWSCI OpRegion

Aptio Setup Utility						
Main	Advanced	Chipset	Boot	Security	Save & Exit	Event Logs
Intel IGD SWSCI OpRegion Configuration						
	DVMT/FIXED Memory		256MB			
	IGD – Boot Type		VBIOS Default			
	Active LVDS		No LVDS			→ ← Select Screen
	LVDS Channel Type		Auto			↑ ↓ Select Item
	LVDS Panel Color Depth		18bit			Enter: Select
	LVDS LCD Panel Type		1024x768 LVDS			+ - Change Field
						F1: General Help
						F2: Previous Values
						F3: Optimized Default
						F4: Save ESC: Exit

DVMT/FIXED Memory

Select DVMT/FIXED Mode Memory size used by Internal Graphics Device. Options are 128MB, 256MB and Maximum.

IGD – Boot Type

Select the Video Device which will be activated during POST. This has no effect if external graphics present. Options are VBIOS Default, CRT, LVDS, DisplayPort, HDMI, DVI, CRT+LVDS, CRT+HDMI and CRT+DVI.

Active LVDS

Select the Active LVDS Configuration.

No LVDS: VBIOS does not enable LVDS.

Int-LVDS: VBIOS enables LVDS driver by Integrated encoder.

SDVO LVDS : VBIOS enables LVDS driver by SDVO encoder.

eDP: LVDS Driven by Int-DisplayPort encoder.

LVDS Channel Type

The default setting is Auto. Other settings are Single and Double.

LVDS Panel Color Depth

The default setting is 18bit. The other option is 24bit.

LVDS LCD Panel Type

The default setting is 1024x768 LVDS.

Intel TDT(AT-p) Configurations

Aptio Setup Utility

Main	Advanced	Chipset	Boot	Security	Save & Exit	Event Logs
Intel Theft Deterrence Technology Configuration						
TDT		Disabled				
TDT Recovery		3				
					→ ← Select Screen ↑ ↓ Select Item Enter: Select +- Change Field F1: General Help F2: Previous Values F3: Optimized Default F4: Save ESC: Exit	

TDT

Enable/Disable TDT in BIOS for testing only.

TDT Recovery

Set the number of times Recovery attempted will be allowed.

USB Configuration

Aptio Setup Utility

Main	Advanced	Chipset	Boot	Security	Save & Exit	Event Logs
USB Configuration					→ ← Select Screen	
USB Devices: 2 Hubs					↑ ↓ Select Item	
Legacy USB Support					Enter: Select	
EHCI Hand-off					+- Change Field	
Device Reset Timeout					F1: General Help	
					F2: Previous Values	
					F3: Optimized Default	
					F4: Save ESC: Exit	

Legacy USB Support

Enables Legacy USB support.

AUTO option disables legacy support if no USB devices are connected.

DISABLE option will keep USB devices available only for EFI applications.

EHCI Hand-off

Enabled/Disabled. This is a workaround for Oses without EHCI hand-off support. The EHCI ownership change should be claimed by EHCI driver.

Device Reset Timeout

USB mass storage device Start Unit command timeout.

Options are: 10 sec / 20 sec / 30 sec / 40 sec.

Super IO Configuration

Aptio Setup Utility

Main	Advanced	Chipset	Boot	Security	Save & Exit	Event Logs
Super IO Configuration					→ ← Select Screen	
Super IO Chip		Fintek F81865			↑ ↓ Select Item	
-> Serial Port 0 Configuration					Enter: Select	
-> Serial Port 1 Configuration					+- Change Field	
-> Serial Port 2 Configuration					F1: General Help	
-> Serial Port 3 Configuration					F2: Previous Values	
Parallel Port Configuration					F3: Optimized Default	
Power Failure			Always off		F4: Save ESC: Exit	
ACPI Shutdown Temperature			Disable			

Serial Port Configuration

Set Parameters of Serial Ports. User can Enable/Disable the serial port and Select an optimal settings for the Super IO Device.

Power Failure

Options are:

Keep last state

Bypass mode

Always on

Always off (default)

Parallel Port Configuration

Set Parameters of the parallel port. The default setting is 378F/IRQ7.

ACPI Shutdown Temperature

The system will shut down automatically under OS with ACPI mode, when the CPU temperature reaches the configured temperature.

H/W Monitor

Aptio Setup Utility

Main	Advanced	Chipset	Boot	Security	Save & Exit	Event Logs
PC Health Status						
CPU Temperature			+51 C			
System Temperature			+35 C			
CPU FAN Speed			7109 RPM			
VCC3V			+3.408 V			
Vcore			+0.928 V		→ ← Select Screen	
5V			+5.087 V		↑ ↓ Select Item	
12V			+11.880V		Enter: Select	
1.5V			+1.552 V		+- Change Field	
VSB3V			+3.392		F1: General Help	
VBAT			+3.184 V		F2: Previous Values	
CPU Fan Smart Fan Control			Disabled		F3: Optimized Default	
					F4: Save ESC: Exit	

Temperatures/Voltages

These fields are the parameters of the hardware monitoring function feature of the motherboard. The values are read-only values as monitored by the system and show the PC health status.

CPU Fan Smart Fan Control

This field enables or disables the smart fan feature. At a certain temperature, the fan starts turning. Once the temperature drops to a certain level, it stops turning again.

Thermal Configuration

Aptio Setup Utility

Main	Advanced	Chipset	Boot	Security	Save & Exit	Event Logs
Thermal Configuration						
Intelligent Power Sharing						
					→ ← Select Screen ↑ ↓ Select Item Enter: Select +- Change Field F1: General Help F2: Previous Values F3: Optimized Default F4: Save ESC: Exit	

Intelligent Power Sharing

- Intelligent power sharing – The default setting is Enabled.
- Mch Turbo – The default setting is Enabled.
- IPS Policy – The default setting is Driver.
- Core Temp Limit – The default setting is Disabled.
- Mch Power Limit – The default setting is Disabled.
- Processor Power Limit - The default setting is Disabled.
- Core Power Limit – The default setting is Disabled.

AMT Configuration

Aptio Setup Utility						
Main	Advanced	Chipset	Boot	Security	Save & Exit	Event Logs
	AMT		Enabled			
	Unconfigure AMT/ME		Disabled			
					→ ← Select Screen ↑ ↓ Select Item Enter: Select +- Change Field F1: General Help F2: Previous Values F3: Optimized Default F4: Save ESC: Exit	

AMT

Options are Enabled and Disabled.

Unconfigure AMT/ME

Perform AMT/ME unconfigure without password operation.

Serial Port Console Redirection

Aptio Setup Utility						
Main	Advanced	Chipset	Boot	Security	Save & Exit	Event Logs
	COM0 (Disabled)					
	Console Redirection		Port is Disabled			
	Serial Port for Out-of-Band Management/ Windows Emergency Management Services (EMS)				→ ← Select Screen ↑ ↓ Select Item Enter: Select +- Change Field F1: General Help F2: Previous Values F3: Optimized Default F4: Save ESC: Exit	
	Console Redirection		Enabled			
	Out-of-Band Mgmt Port		COM0 (Disabled)			
	Data Bits		8			
	Parity		None			
	Stop Bits		1			
	Terminal Type		VT-UTF8			

Console Redirection

Console Redirection Enable/Disable.

Terminal Type

VT-UTF8 is the preferred terminal type for out-of-band management. The next best choice is VT100+ and then VT100.

Chipset Settings

This section allows you to configure and improve your system and allows you to set up some system features according to your preference.

Aptio Setup Utility						
Main	Advanced	Chipset	Boot	Security	Save & Exit	Event Logs
	Enable CSID			Disabled		
	▶ North Bridge					→ ← Select Screen
	▶ South Bridge					↑ ↓ Select Item
	▶ ME Subsystem					Enter: Select
						+ - Change Field
						F1: General Help
						F2: Previous Values
						F3: Optimized Default
						F4: Save ESC: Exit

Enable CSID

By default, this item is disabled. Enable Compatible Revision ID.

North Bridge

This item shows the North Bridge Parameters.

South Bridge

This item shows the South Bridge Parameters.

ME Subsystem

This item shows the ME Subsystem Parameters.

North Bridge

This section allows you to configure the North Bridge Chipset.

Aptio Setup Utility						
Main	Advanced	Chipset	Boot	Security	Save & Exit	Event Logs
Memory Information						
CPU Type			Arrandale			
Total Memory			4096 MB (DDR3 1066)			
Memory Slot0			2048 MB (DDR3 1066)			
Memory Slot1			0			
Memory Slot2			2048 MB (DDR3 1066)			
Memory Slot3			140			
CAS# Latency(tCL)			7			
RAS# Active Time(tRAS)			20			
Row Precharge Time(tRP)			7			
RAS# to CAS# Delay(tRCD)			7			
Row Refresh Cycle Timea(tRFC)			60			
Write to Read Delay(tWTR)			4			
Active to Active Delay(tRRD)			4			
Read CAS# Precharge(tRTP)			5			
Low MMIO Align			64M			
Initiate Graphic Adapter			PEG/IGD			
Graphics Turbo IMON Current			31			
VT-d			Disabled			
PCI Express Compliance Mode			Disabled			
PCI Express Port			Auto			
IGD Memory			32M			
						→ ← Select Screen ↑ ↓ Select Item Enter: Select +- Change Field F1: General Help F2: Previous Values F3: Optimized Default F4: Save ESC: Exit

Low MMIO Align

Low MMIO resources align at 64MB/1024MB.

Initiate Graphic Adapter

Select which graphics controller to use as the primary boot device.

Options are IGD, PCI/IGD, PCI/PEG, PEG/IGD, PEG/PCI and SG.

Graphics Turbo IMON Current

Graphics turbo IMON current values supported (14-31).

VT-d

VT-d Enable/Disable.

PCI Express Compliance Mode

PCI Express Compliance Mode Enable/Disable.

PCI Express Port

Options are Disabled, Enabled and Auto.

IGD Memory

IGD Share Memory Size. Options are Disable, 32M, 64M and 128M.

PAVP Mode

Select PAVP Mode used by Internal Graphics Device. Options are Disabled and Enabled.

PEG Force Gen1

PCI Express Port Force Gen1. Options are Disabled and

SB Chipset Configuration

This section allows you to configure the South Bridge Chipset.

Aptio Setup Utility						
Main	Advanced	Chipset	Boot	Security	Save & Exit	Event Logs
SB Chipset Configuration						
SMBus Controller			Enabled			
GbE Controller			Enabled			
Wake on LAN from S5			Enabled			
SLP_S4 Assertion Stretch Enable			Enabled			
SLP_S4 Assertion Width			1-2 Seconds			
Audio Configuration						
Azalia HD Audio			Enabled		→ ← Select Screen	
Azalia Internal HDMI codec			Enabled		↑ ↓ Select Item	
High Precision Event Timer Configuration						
High Precision Timer			Enabled		Enter: Select	
PCI Express Ports Configuration						
USB Configuration						
					+- Change Field	
					F1: General Help	
					F2: Previous Values	
					F3: Optimized Default	
					F4: Save ESC: Exit	

SMBus Controller

SMBus Controller help.

GbE Controller

This is constantly enabled.

Wake on LAN from S5

Wake on LAN from S5 help.

SLP_S4 Assertion Stretch Enable

Select a minimum assertion width of the SLP_S4# signal.

Audio Configuration

The Audio Configuration settings Enable/Disable the Azalia HD Audio and the Azalia internal HDMI codec.

High Precision Event Timer Configuration

Enable/or Disable the High Precision Event Timer.

PCI Express Ports Configuration

Enable or Disable the PCI Express Ports in the Chipset.

Aptio Setup Utility						
Main	Advanced	Chipset	Boot	Security	Save & Exit	Event Logs
PCI Express Ports Configuration						
PCI Express Port 1			Auto		→ ← Select Screen ↑ ↓ Select Item Enter: Select +- Change Field F1: General Help F2: Previous Values F3: Optimized Default F4: Save ESC: Exit	
PCI Express Port 2			Auto			
PCI Express Port 3			Auto			
PCI Express Port 4			Auto			
PCI Express Port 5			Auto			
PCI Express Port 6			Auto			
PCI Express Port 7			Auto			
PCI Express Port 8			Auto			

USB Configuration

Enable/Disable All USB Devices, USB 2.0 (EHCI) Support and RMH Support. The setting of AUTO on RMH Support Enable RMH support on Ibex Peak B0 Stepping.

Aptio Setup Utility						
Main	Advanced	Chipset	Boot	Security	Save & Exit	Event Logs
USB Configuration						
All USB Devices			Enabled		→ ← Select Screen ↑ ↓ Select Item Enter: Select +- Change Field F1: General Help F2: Previous Values F3: Optimized Default F4: Save ESC: Exit	
EHCI Controller 1			Enabled			
EHCI Controller 2			Enabled			
RMH Support			Auto			
USB Port 0			Enabled			
USB Port 1			Enabled			
USB Port 2			Enabled			
USB Port 3			Enabled			
USB Port 4			Enabled			
USB Port 5			Enabled			
USB Port 6			Enabled			
USB Port 7			Enabled			
USB Port 8			Enabled			
USB Port 9			Enabled			
USB Port 10			Enabled			
USB Port 11			Enabled			
USB Port 12			Enabled			
USB Port 13			Enabled			

Intel ME Subsystem

This section allows you to configure the PCI settings.

Aptio Setup Utility						
Main	Advanced	Chipset	Boot	Security	Save & Exit	Event Logs
Intel ME Subsystem Configuration						
ME Version			6.0.3.1195		→ ← Select Screen	
ME Subsystem			Enabled		↑ ↓ Select Item	
End of Post Message			Enabled		Enter: Select	
Execute ME8x			Enabled		+- Change Field	
					F1: General Help	
					F2: Previous Values	
					F3: Optimized Default	
					F4: Save ESC: Exit	

ME Version

Launches (Enabled/Disabled) the boot option for legacy network devices.

ME Subsystem

Launches (Enabled/Disabled) the boot option for legacy network devices.

End of Post Message

Launches (Enabled/Disabled) the boot option for legacy network devices.

Execute ME8x

Launches (Enabled/Disabled) the boot option for legacy network devices.

Boot Settings

This section allows you to configure the boot settings according to your preference.

Aptio Setup Utility						
Main	Advanced	Chipset	Boot	Security	Save & Exit	Event Logs
Boot Configuration						
Quiet Boot			Disabled			
Fast Boot			Disabled			
Setup Prompt Timeout			1			
Bootup NumLock State			On			
CSM16 Module Version			07.60			
GateA20 Active			Upon Request			
Option ROM Messages			Force BIOS		→ ← Select Screen	
Interrupt 19 Capture			Disabled		↑ ↓ Select Item	
Boot Option Priorities					Enter: Select	
Boot Option #1			SATA: ATAPI iH...)		+- Change Field	
						F1: General Help
						F2: Previous Values
						F3: Optimized Default
						F4: Save ESC: Exit

Quiet Boot

Enables/Disables Quiet Boot option.

Fast Boot

Enables/Disables boot with initialization of a minimal set of devices required to launch active boot option. Has no effect for BBS boot options.

Setup Prompt Timeout

Number of seconds to wait for setup activation key.
65535(0xFFFF) means indefinite waiting.

Bootup NumLock State

Select the keyboard NumLock state.

GateA20 Active

UPON REQUEST – GA20 can be disabled using BIOS services.

ALWAYS – do not allow disabling GA20; this option is useful when any RT code is executed above 1MB.

Option ROM Messages

Set display mode for Option ROM. Options are Force BIOS and Keep Current.

Interrupt 19 Capture

Enable: Allows Option ROMs to trap Int 19.

Boot Option Priorities

Sets the system boot order.

Hard Drive BBS Priorities

Set the order of the legacy devices in this group.

Security Settings

This section allows you to configure and improve your system and allows you to set up some system features according to your preference.

Aptio Setup Utility						
Main	Advanced	Chipset	Boot	Security	Save & Exit	Event Logs
Password Description						
If ONLY the Administrator's password is set, then this only limits access to Setup and is only asked for when entering Setup.						
If ONLY the User's password is set, then this is a power on password and must be entered to boot or enter Setup. In Setup the User will have Administrator rights						
Administrator Password						
User Password						
				→ ← Select Screen ↑ ↓ Select Item Enter: Select +- Change Field F1: General Help F2: Previous Values F3: Optimized Default F4: Save ESC: Exit		

Administrator Password

Set Setup Administrator Password.

User Password

Set User Password.

Save & Exit Settings

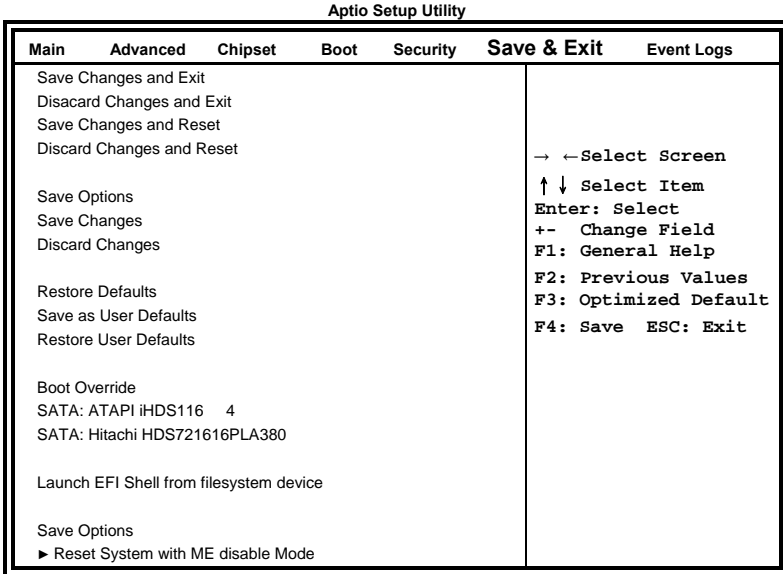

Save Changes and Exit

Exit system setup after saving the changes.

Discard Changes and Exit

Exit system setup without saving any changes.

Save Changes and Reset

Reset the system after saving the changes.

Discard Changes and Reset

Reset system setup without saving any changes.

Save Changes

Save Changes done so far to any of the setup options.

Discard Changes

Discard Changes done so far to any of the setup options.

Restore Defaults

Restore/Load Defaults values for all the setup options.

Save as User Defaults

Save the changes done so far as User Defaults.

Restore User Defaults

Restore the User Defaults to all the setup options.

Boot Override

Pressing ENTER causes the system to enter the OS.

Launch EFI Shell from filesystem device

Attempts to Launch EFI Shell application (Shellx64.efi) from one of the available filesystem devices.

Reset System with ME disable Mode

ME will run into the temporary disable mode.

Event Logs

This section allows you to configure the Smbios Event Log, according to your preference.

Aptio Setup Utility

Main	Advanced	Chipset	Boot	Security	Save & Exit	Event Logs
<p>▶ Change Smbios Event Log Settings</p> <p>View Smbios Event Log</p> <p>View System Event Log</p>						<p>Press Enter to change Smbios Event Log Configuration</p> <p>→ ← Select Screen</p> <p>↑ ↓ Select Item</p> <p>Enter: Select</p> <p>+ - Change Field</p> <p>F1: General Help</p> <p>F2: Previous Values</p> <p>F3: Optimized Default</p> <p>F4: Save ESC: Exit</p>

Aptio Setup Utility

Main	Advanced	Chipset	Boot	Security	Save & Exit	Event Logs
Enabling/Disabling Options						<p>Change this to enable/disable all features of Smbios Logging during boot.</p> <p>→ ← Select Screen</p> <p>↑ ↓ Select Item</p> <p>Enter: Select</p> <p>+ - Change Field</p> <p>F1: General Help</p> <p>F2: Previous Values</p> <p>F3: Optimized Default</p> <p>F4: Save ESC: Exit</p>
Smbios Event Log				Enabled		
Erasing Settings						
Erase Event Log				No		
When Log is Full				Do Nothing		
Smbios Event Log Standard Settings						
MECI				1		
METW				60		
Custom Options						
Log OEM Codes				Enabled		
Convert OEM Codes				Disabled		
NOTE: All values changed here do not take effect until computer is restarted						

Drivers Installation

This section describes the installation procedures for software and drivers under Windows operating systems. The software and drivers are included with the motherboard. If you find the items missing, please contact the vendor where you made the purchase. The contents of this section include the following:

Intel Chipset Software Installation Utility	52
VGA Drivers Installation	54
Realtek HD Audio Driver Installation	56
LAN Drivers Installation	57
Intel® Management Engine Interface	60

Intel Chipset Software Installation Utility

The Intel Chipset Drivers should be installed first before the software drivers to enable Plug & Play INF support for Intel chipset components. Follow the instructions below to complete the installation.

1. Insert the CD that comes with the board. Click **Intel** and then **Intel(R) QM57 Chipset Drivers**.
2. Click **Intel(R) Chipset Software Installation Utility**.



3. When the Welcome screen to the Intel® Chipset Device Software appears, click **Next** to continue.

4. Click ***Yes*** to accept the software license agreement and proceed with the installation process.
5. On the Readme File Information screen, click ***Next*** to continue the installation.
6. The Setup process is now complete. Click ***Finish*** to restart the computer and for changes to take effect.

VGA Drivers Installation

NOTE: Before installing the *Intel(R) QM57 Chipset Family Graphics Driver*, the Microsoft .NET Framework 3.5 SPI should be first installed.

To install the VGA drivers, follow the steps below.

1. Insert the CD that comes with the board. Click *Intel* and then *Intel(R) QM57 Chipset Drivers*.
2. Click *Intel(R) QM57 Chipset Family Graphics Driver*.

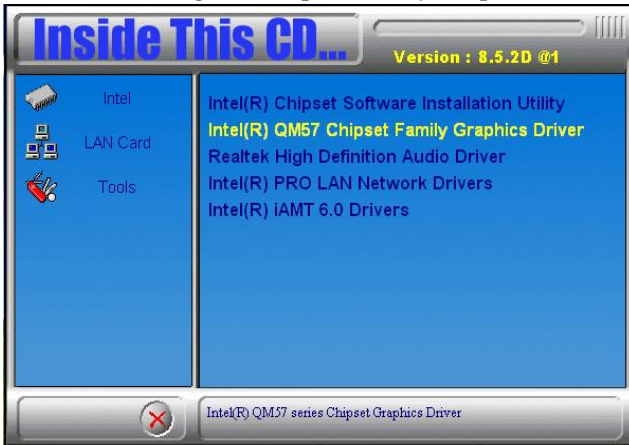

3. When the Welcome screen appears, click *Next* to continue.



4. Click **Yes** to agree with the license agreement and continue the installation.
5. On the Readme File Information screen, click **Next** to continue the installation of the Intel® Graphics Media Accelerator Driver.
6. On Setup Progress screen, click **Next** to continue.
7. Setup complete. Click **Finish** to restart the computer and for changes to take effect.

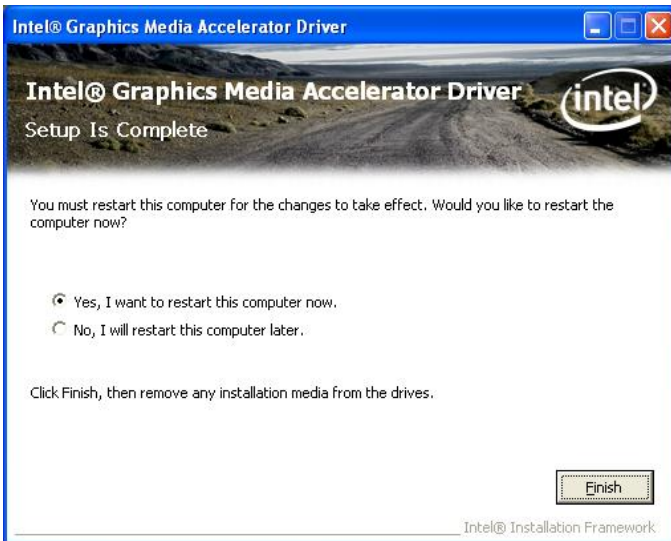

Realtek HD Audio Driver Installation

Follow the steps below to install the Realtek HD Audio Drivers.

1. Insert the CD that comes with the board. Click **Intel** and then **Intel(R) QM57 Chipset Drivers**.
2. Click **Realtek High Definition Audio Driver**.



3. On the Welcome to the InstallShield Wizard screen, click **Next**.

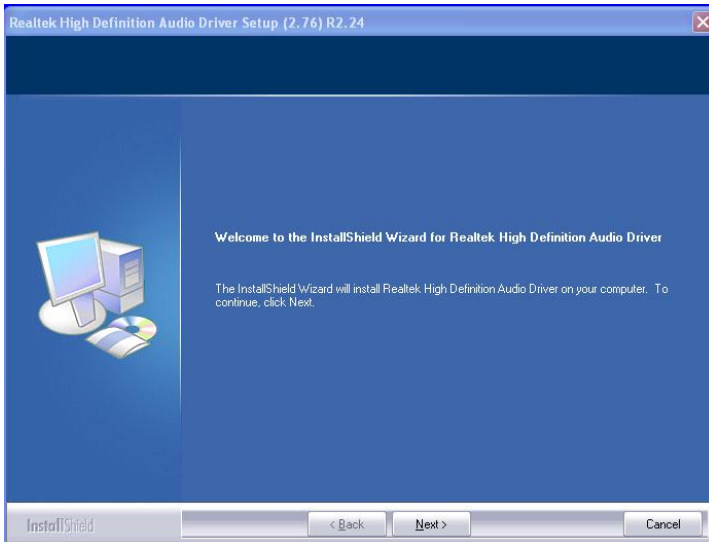

3. InstallShield Wizard is complete. Click **Finish** to restart the computer.

LAN Drivers Installation

Follow the steps below to install the Intel LAN drivers.

1. Insert the CD that comes with the board. Click *Intel* and then *Intel(R) QM57 Chipset Drivers*.
2. Click *Intel(R) PRO LAN Network Driver*.



3. When the Welcome screen appears, click *Next*. On the next screen, click *Yes* to to agree with the license agreement.



4. Click the checkbox for **Drivers** in the Setup Options screen to select it and click **Next** to continue.

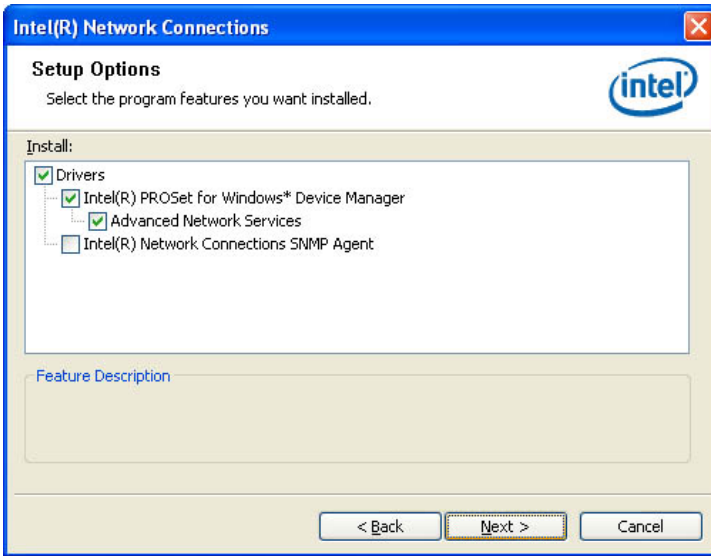

5. The wizard is ready to begin installation. Click **Install** to begin the installation.

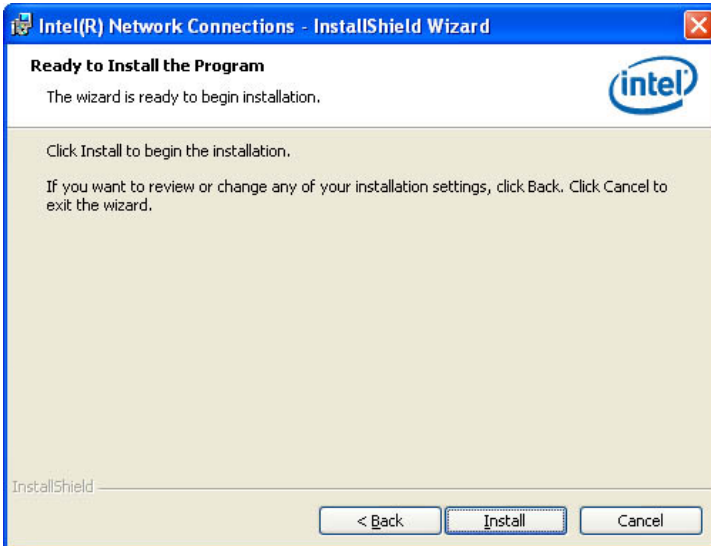

6. When InstallShield Wizard is complete, click **Finish**.

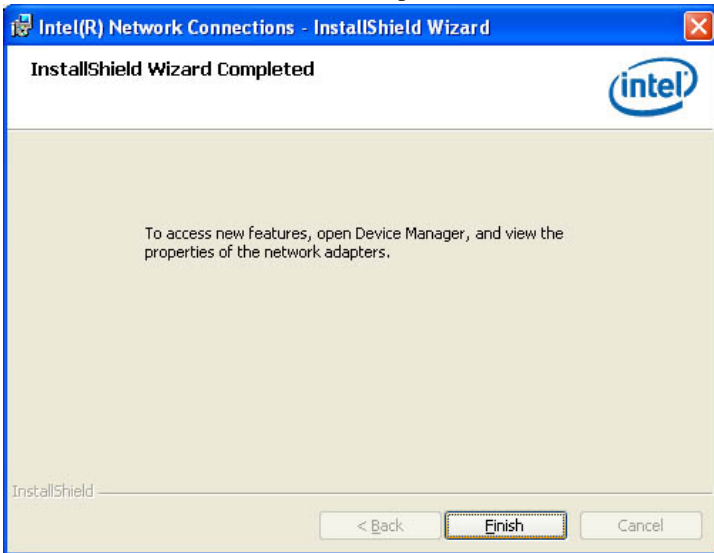

Intel® Management Engine Interface

NOTE: Before installing the *Intel(R) AMT 6.0 Drivers*, the Microsoft .NET Framework 3.5 SPI should be first installed.



Follow the steps below to install the Intel Management Engine.

1. Insert the drivers disc that comes with the motherboard. Click *Intel* and then *Intel(R) AMT 6.0 Drivers*.



2. When the Welcome screen to the InstallShield Wizard for Intel® Management Engine Components, click *Next*. On the next screen, click *Yes* to agree with the license agreement.



2. When the Setup Progress screen appears, click *Next*. Then, click *Finish* when the setup progress has been successfully installed.

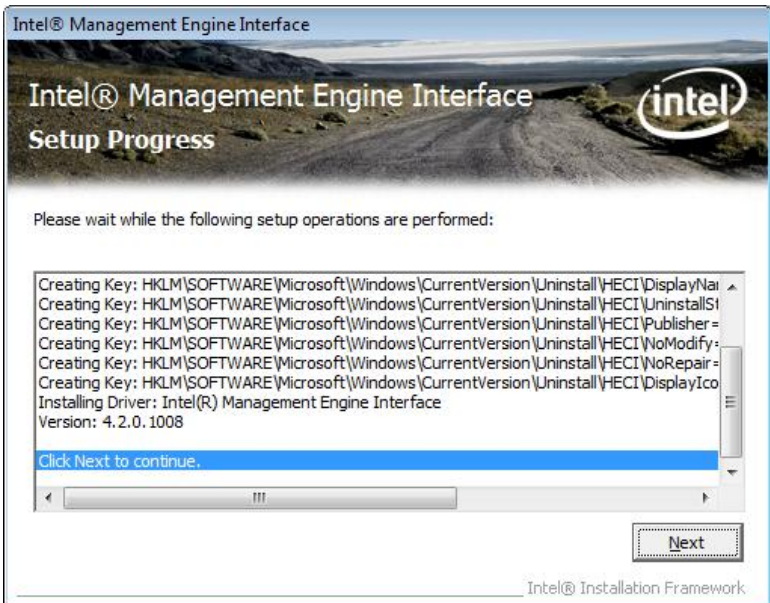



Appendix

A. I/O Port Address Map

Each peripheral device in the system is assigned a set of I/O port addresses which also becomes the identity of the device. The following table lists the I/O port addresses used.

Address	Device Description
000h - 01Fh	DMA Controller #1
020h - 03Fh	Interrupt Controller #1
040h - 05Fh	Timer
060h - 06Fh	Keyboard Controller
070h - 07Fh	Real Time Clock, NMI
080h - 09Fh	DMA Page Register
0A0h - 0BFh	Interrupt Controller #2
0C0h - 0DFh	DMA Controller #2
0F0h	Clear Math Coprocessor Busy Signal
0F1h	Reset Math Coprocessor
1F0h - 1F7h	IDE Interface
278h - 27Fh	Parallel Port #2(LPT2)
2E8h - 2EFh	Serial Port #4(COM4)
2F8h - 2FFh	Serial Port #2(COM2)
2B0h - 2DFh	Graphics adapter Controller
360h - 36Fh	Network Ports
3B0h - 3BFh	Monochrome & Printer adapter
3C0h - 3CFh	EGA adapter
3D0h - 3DFh	CGA adapter
3E8h - 3EFh	Serial Port #3(COM3)
3F8h - 3FFh	Serial Port #1(COM1)

B. Interrupt Request Lines (IRQ)

Peripheral devices use interrupt request lines to notify CPU for the service required. The following table shows the IRQ used by the devices on board.

Level	Function
IRQ0	System Timer Output
IRQ1	Keyboard
IRQ2	Interrupt Cascade
IRQ3	Serial Port #2
IRQ4	Serial Port #1
IRQ5	Reserved
IRQ6	Reserved
IRQ7	Reserved
IRQ8	Real Time Clock
IRQ9	Reserved
IRQ10	Serial Port #3
IRQ11	Serial Port #4
IRQ12	PS/2 Mouse
IRQ13	80287
IRQ14	Primary IDE
IRQ15	Secondary IDE

C. Watchdog Timer Configuration

The WDT is used to generate a variety of output signals after a user programmable count. The WDT is suitable for use in the prevention of system lock-up, such as when software becomes trapped in a deadlock. Under these sorts of circumstances, the timer will count to zero and the selected outputs will be driven. Under normal circumstance, the user will restart the WDT at regular intervals before the timer counts to zero.

SAMPLE CODE:

```
//-----
//
// THIS CODE AND INFORMATION IS PROVIDED "AS IS" WITHOUT WARRANTY OF ANY
// KIND, EITHER EXPRESSED OR IMPLIED, INCLUDING BUT NOT LIMITED TO THE
// IMPLIED WARRANTIES OF MERCHANTABILITY AND/OR FITNESS FOR A PARTICULAR
// PURPOSE.
//
//-----
#include <dos.h>
#include <conio.h>
#include <stdio.h>
#include <stdlib.h>
#include "F81865.H"
//-----
int main (int argc, char *argv[]);
void EnableWDT(int);
void DisableWDT(void);
//-----
int main (int argc, char *argv[])
{
    unsigned char bBuf;
    unsigned char bTime;
    char **endptr;

    char SIO;

    printf("Fintek 81865 watch dog program\n");

    SIO = Init_F81865();
    if (SIO == 0)
    {
        printf("Can not detect Fintek 81865, program abort.\n");
        return(1);
    }/if (SIO == 0)

    if (argc != 2)
    {
        printf(" Parameter incorrect!!\n");
        return (1);
    }

    bTime = strtol (argv[1], endptr, 10);
    printf("System will reset after %d seconds\n", bTime);

    if (bTime)
    {
        EnableWDT(bTime);
    }
    else
    {
        DisableWDT();
    }
}
```

```

    return 0;
}
//-----
void EnableWDT(int interval)
{
    unsigned char bBuf;

    bBuf = Get_F81865_Reg(0x2B);
    bBuf &= (~0x20);
    Set_F81865_Reg(0x2B, bBuf);                //Enable WDTO

    Set_F81865_LD(0x07);                      //switch to logic device 7
    Set_F81865_Reg(0x30, 0x01);              //enable timer

    bBuf = Get_F81865_Reg(0xF5);
    bBuf &= (~0x0F);
    bBuf |= 0x52;
    Set_F81865_Reg(0xF5, bBuf);              //count mode is second

    Set_F81865_Reg(0xF6, interval);          //set timer

    bBuf = Get_F81865_Reg(0xFA);
    bBuf |= 0x01;
    Set_F81865_Reg(0xFA, bBuf);              //enable WDTO output

    bBuf = Get_F81865_Reg(0xF5);
    bBuf |= 0x20;
    Set_F81865_Reg(0xF5, bBuf);              //start counting
}
//-----
void DisableWDT(void)
{
    unsigned char bBuf;

    Set_F81865_LD(0x07);                    //switch to logic device 7

    bBuf = Get_F81865_Reg(0xFA);
    bBuf &= ~0x01;
    Set_F81865_Reg(0xFA, bBuf);              //disable WDTO output

    bBuf = Get_F81865_Reg(0xF5);
    bBuf &= ~0x20;
    bBuf |= 0x40;
    Set_F81865_Reg(0xF5, bBuf);              //disable WDT
}
//-----

```

```

//-----
//
// THIS CODE AND INFORMATION IS PROVIDED "AS IS" WITHOUT WARRANTY OF ANY
// KIND, EITHER EXPRESSED OR IMPLIED, INCLUDING BUT NOT LIMITED TO THE
// IMPLIED WARRANTIES OF MERCHANTABILITY AND/OR FITNESS FOR A PARTICULAR
// PURPOSE.
//
//-----
#include "F81865.H"
#include <dos.h>
//-----
unsigned int F81865_BASE;
void Unlock_F81865 (void);
void Lock_F81865 (void);
//-----
unsigned int Init_F81865(void)
{
    unsigned int result;
    unsigned char ucDid;

    F81865_BASE = 0x4E;
    result = F81865_BASE;

    ucDid = Get_F81865_Reg(0x20);
    if (ucDid == 0x07) //Fintek 81865
    {
        goto Init_Finish;
    }

    F81865_BASE = 0x2E;
    result = F81865_BASE;

    ucDid = Get_F81865_Reg(0x20);
    if (ucDid == 0x07) //Fintek 81865
    {
        goto Init_Finish;
    }

    F81865_BASE = 0x00;
    result = F81865_BASE;

Init_Finish:
    return (result);
}
//-----
void Unlock_F81865 (void)
{
    outportb(F81865_INDEX_PORT, F81865_UNLOCK);
    outportb(F81865_INDEX_PORT, F81865_UNLOCK);
}
//-----
void Lock_F81865 (void)
{
    outportb(F81865_INDEX_PORT, F81865_LOCK);
}
//-----
void Set_F81865_LD( unsigned char LD)
{
    Unlock_F81865();
    outportb(F81865_INDEX_PORT, F81865_REG_LD);
    outportb(F81865_DATA_PORT, LD);
    Lock_F81865();
}
//-----
void Set_F81865_Reg( unsigned char REG, unsigned char DATA)
{
    Unlock_F81865();
    outportb(F81865_INDEX_PORT, REG);
    outportb(F81865_DATA_PORT, DATA);
    Lock_F81865();
}
//-----

```

```

unsigned char Get_F81865_Reg(unsigned char REG)
{
    unsigned char Result;
    Unlock_F81865();
    outportb(F81865_INDEX_PORT, REG);
    Result = inportb(F81865_DATA_PORT);
    Lock_F81865();
    return Result;
}
//-----

//-----
//
// THIS CODE AND INFORMATION IS PROVIDED "AS IS" WITHOUT WARRANTY OF ANY
// KIND, EITHER EXPRESSED OR IMPLIED, INCLUDING BUT NOT LIMITED TO THE
// IMPLIED WARRANTIES OF MERCHANTABILITY AND/OR FITNESS FOR A PARTICULAR
// PURPOSE.
//
//-----
#ifndef __F81865_H
#define __F81865_H                1
//-----
#define F81865_INDEX_PORT        (F81865_BASE)
#define F81865_DATA_PORT        (F81865_BASE+1)
//-----
#define F81865_REG_LD            0x07
//-----
#define F81865_UNLOCK            0x87
#define F81865_LOCK              0xAA
//-----
unsigned int Init_F81865(void);
void Set_F81865_LD(unsigned char);
void Set_F81865_Reg(unsigned char, unsigned char);
unsigned char Get_F81865_Reg(unsigned char);
//-----
#endif __F81865_H

```